

# Data Sheet



Article number: 604144034020

Description: Timing belt pulley with hub  
HTD 34 8M 20

## Measures

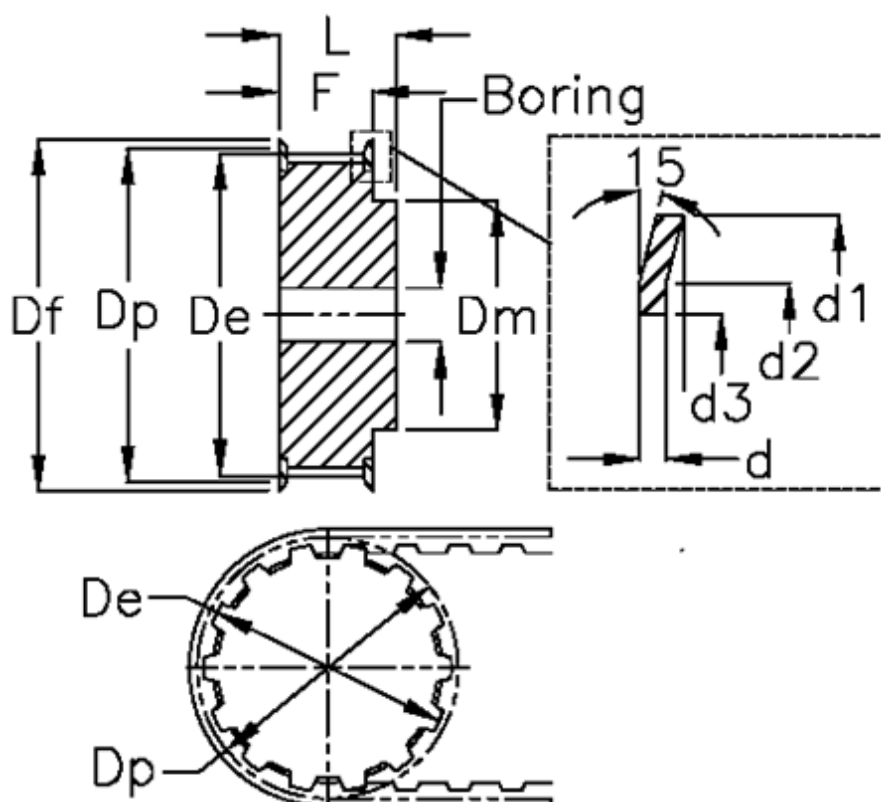

Bore = 15	Dp = 86.58
d = 1.5	F = 28
d1 = 91	Flange type = F31
d2 = 85.5	L = 38
d3 = 76	Tooth number = 34
De = 85.22	Type = 8M
Df = 91	Weight = 1.4
Dm = 70	Width = 20